

Encoders

magnetic Encoder, digital outputs, 2 channels,
64 - 1024 lines per revolution

For combination with
DC-Micromotors
Brushless DC-Servomotors

Series IE2 – 1024

		IE2 – 64	IE2 – 128	IE2 – 256	IE2 – 512	IE – 1024	
Lines per revolution	N	64	128	256	512	1024	
Frequency range, up to ¹⁾	f	20	40	80	160	300	kHz
Signal output, square wave		2					channels
Supply voltage	U _{DD}	4,5 ... 5,5					V DC
Current consumption, typical ²⁾	I _{DD}	typ. 8,5, max. 12					mA
Output current, max. allowable ³⁾	I _{OUT}	5					mA
Phase shift, channel A to B	Φ	90 ± 45					°e
Signal rise/fall time, max. (C _{LOAD} = 50 pF)	tr/tf	0,1 / 0,1					µs
Inertia of code disc ⁴⁾	J	0,09					gcm ²
Operating temperature range		– 25 ... + 85					°C

¹⁾ speed (rpm) = f (Hz) x 60/N

²⁾ U_{DD Enc} = 5V: with unloaded outputs

³⁾ U_{DD Enc} = 5V: low logic level < 0,5V, high logic level > 4,5V: CMOS- and TTL compatible

⁴⁾ For the brushless DC-Servomotors the inertia of code disc is J = 0,14 gcm²

For combination with motor

Dimensional drawing A	<L1 [mm]	Dimensional drawing C	<L1 [mm]
1336...CXR-123	47,5	1727...C-123	38,2
		1741...CXR-123	49,4
Dimensional drawing B	<L1 [mm]	Dimensional drawing D	<L1 [mm]
1516...SR	18,2	1628...B-K313	38,8
1524...SR	26,2	2036...B-K313	46,8
1717...SR	19,4	2057...B-K313	68,3
1724...SR	26,4		
2224...SR	26,6		
2232...SR	34,6		

Features

These incremental shaft encoders in combination with the FAULHABER DC-Micromotors and Brushless DC-Servomotors are used for the indication and control of both shaft velocity and direction of rotation as well as for positioning.

The encoder is integrated in the DC-Micromotors SR-Series and extends the overall length by only 1,4 mm. Built-on option for DC-Micromotors and Brushless DC-Servomotors.

Hybrid circuits with sensors and a low inertia magnetic disc provide two channels with 90° phase shift.

The supply voltage for the encoder and the DC-Micromotor as well as the two channel output signals are interfaced through a ribbon cable with connector.

Details for the DC-Micromotors and suitable reduction gearheads are on separate catalogue pages.

Output signals / Circuit diagram

Output circuit

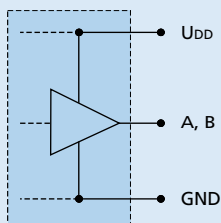

Output signals

with clockwise rotation as seen from the shaft end

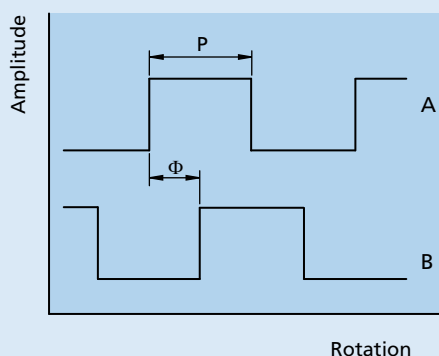

Admissible deviation of phase shift:

$$\Delta\Phi = \left| 90^\circ - \frac{\Phi}{P} * 180^\circ \right| \leq 45^\circ$$

Connector information / Variants

No.	Function
1	Motor - *
2	Motor + *
3	GND
4	U ₀₀
5	Channel B
6	Channel A

*Note: The terminal resistance of all motors with precious metal commutation is increased by approx. 0.4 Ω, and the max. allowable motor current in combination is 1A, depending on the motor can also be lower. Motors with graphite commutation have separate motor leads and higher motor current is allowed.

Connection Encoder

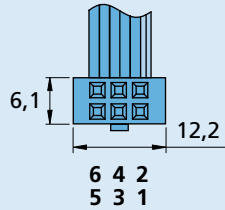

Cable
PVC-ribbon cable
6-conductors, 0,09 mm²

Connector
DIN-41651
grid 2,54 mm

Full product description

■ Example:
1336U012C-123 IE2-1024
1516T006SR IE2-256

Dimensional drawing A

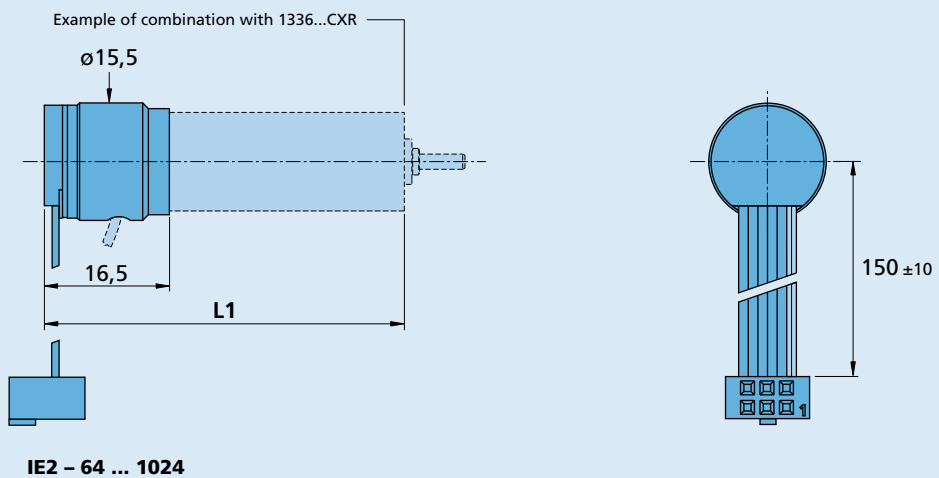

Dimensional drawing B

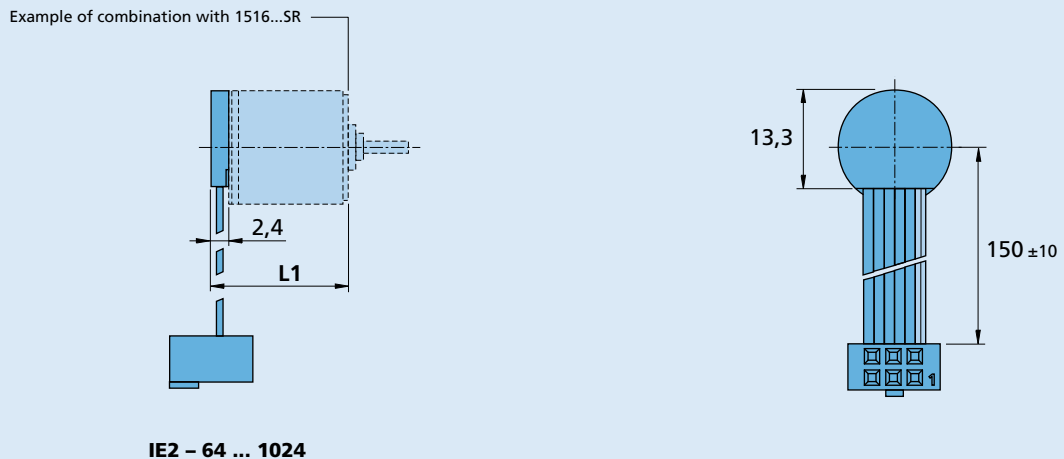

Dimensional drawing C

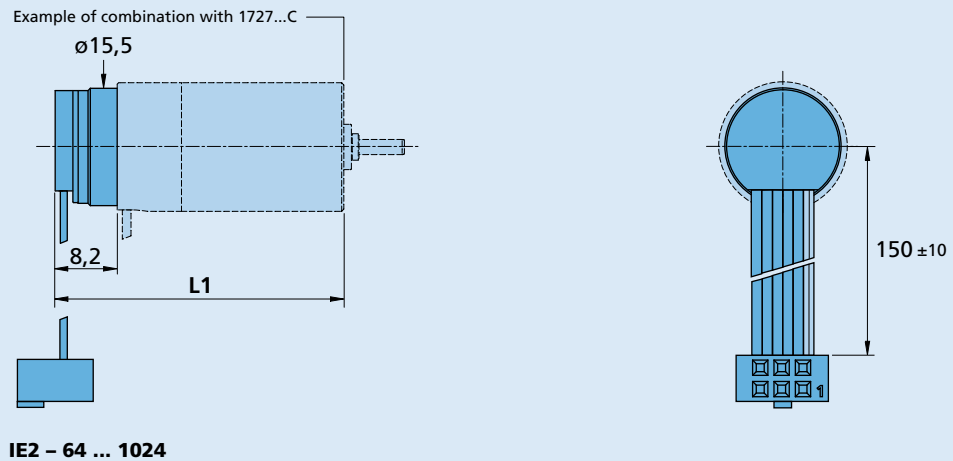

Dimensional drawing D

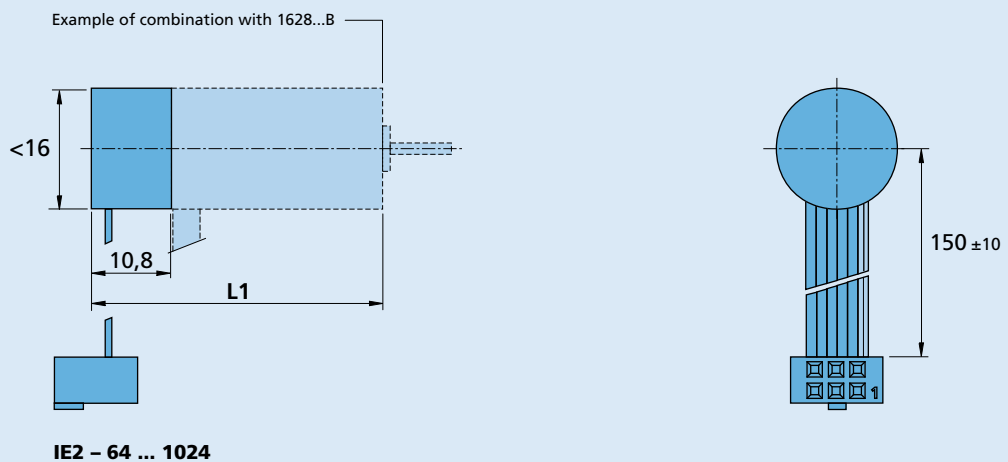

Interface board for MCDC 3002 S

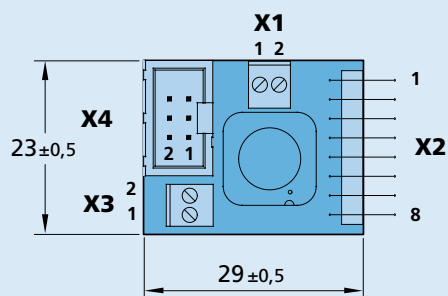

Interface Board IE2
Part. No.: 6501.00143

Connection

Pin	Connection X1	Pin	Connection X3
1	5. In	1	Motor -
2	4. In	2	Motor +

Pin	Connection X2	Pin	Connection X4
1	4. In	1	Motor -
2	Channel A	2	Motor +
3	Channel B	3	SGND
4	U _{DD}	4	U _{DD}
5	SGND	5	Channel B
6	Motor +	6	Channel A
7	Motor -		
8	5. In		