

ENG www.phytron.eu/vss



VSS Stepper Motor

For Applications up to Ultra-high-vacuum

RoHS
compliant



Motors for use in vacuum should not only withstand the vacuum (no bursting of air inclusions), they must not contaminate the vacuum either. By selecting suitable materials and optimised conditioning processes phytron VSS stepper motors are ideally suited for use in a vacuum. Through many years of experience with special materials for use in Space, we have put a focus on materials with minimal molecular outgassing and high heat resistance. This is the prerequisite for a high vacuum quality and genuine measurement results in scientific and medical applications.

For exact positioning in vacuum, stepper motors are therefore particularly suitable because they can precisely position even without sensitive feedback providers. Therefore

phytron VSS stepper motors can be used in particularly challenging environmental conditions (radiation, cryo-temperatures and in a modified design even in Space).

Since stepper motors do not generate jitter effects while holding a position, this technology is ideal for precisely aligning optical instruments, mirrors, antennas or samples e.g. in high-resolution microscopes, particle accelerators or molecular analysis devices.

The VSS series is completely manufactured in Germany. You have special requirements? We are pleased to develop a tailored design for your application.

In Focus



High Temperature



Vacuum



Radiation Resistance

- 2-phase stepper motors
- Holding torques from 3.4 mNm to 13 Nm
- Diameters from 19 to 125 mm
- Number of steps 200 (standard)
- Step accuracy 5% for 1.8°
- Operating voltage (power stage)
Size 19 to 57: 70 V_{DC}
Size 80 to 126: 120 V_{DC}
- Protection class IP 20
- Standard connection: 4-lead parallel (option: series or 8-lead)
- Outgassing holes to avoid pockets of trapped gas

Options

- VGPL precision planetary gear or Harmonic Drive gear
- Thermocouple type KTC/ Pt100 resistor sensor
- Resolver
- Double shaft

Customised solutions

- Operating in an aggressive environment
- Clean room applications to clean room class ISO 5 (acc. to ISO 14644-1)
- Motors with spindle

Highlights



Performance & Lifetime

phytron in-Vacuum motors are based on a technology that can also be found in the most challenging projects of our time. From a variety of satellites up to the Mars rover Curiosity: phytron motors drive applications in distant worlds - highly accurate, reliable and durable. Driven within their specification range, high quality components and a proven design make sure: These motors don't let you down!



Cleanliness

phytron motors for use in ultra high vacuum (UHV) contain only materials that also meet the requirements of the ECSS (European Space regulations). Thus, each material has a maximum TML (Total Mass Loss) value < 1% and a maximum CVCM (Volatile Mass Losses) value < 0.1%. You will receive your UHV motor, double-wrapped and vacuum sealed.

Extreme

phytron VSS Stepper Motor

**Conditioning**

The combination of high quality materials and a special conditioning process allow minimal outgassing rates. So a vacuum of 10^{-11} hPa can be achieved depending on the application. For this purpose, individual components of the UHV motors, such as the wound stator, are specially conditioned before installation, so that outgassing materials cannot be deposited in the ball bearings or inside the motor. The fully assembled motor is outgassed by a phytron process at least 200 °C in vacuum chambers. Increased outgassing temperatures are available on request. The rule of thumb: the outgassing rate decreases with a decimal power for every 100 °C increase of the outgassing temperature. In the actual application the motor should always be driven at least 40 °C below the outgassing temperature.

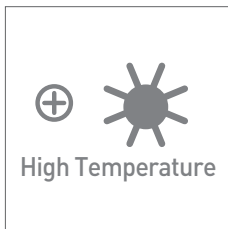
**Temperature Management**

All materials selected for the UHV motors can withstand a short-term winding temperature of up to 300° C. Due to the lack of convection in vacuum, the motors can heat up very quickly and often work at a high temperature level - depending on the duty-cycle. In our UHV motors we integrate a thermocouple to allow monitoring of the exact winding temperature. All vacuum motors can be ordered as an alternative to the thermocouple also with platinum probes (PT) or customer- specific sensors. This is how you protect your motors safe from overheating.

**Adhesives**

The adhesives represent an optimum of strength, ductility, low outgassing rates and thermal resistance. The outgassing rates (TML, CVCM) comply with the European and US-American Space standards. While the first adhesive is not brittle even at 4 K, the second adhesive retains sufficient strength even at a winding temperature of 300 °C for short periods without taking damage.

**Bearings**

The usage of un-lubricated ball bearings can cause so-called cold welding, and thus degrade and completely block the bearing. Therefore, it is advisable to use lubricated ball bearings whenever the application permits. For this purpose a special vacuum grease is necessary to provide not only low outgassing rates but also an extended life-time for the bearing. There is special lubrication for temperatures down to -50 °C or even -70 °C. However, the viscosity is so high that the efficiency decreases considerably. In low temperatures, the use of dry-lubricated bearings is recommended.

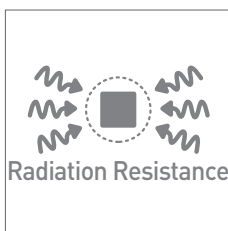
**Radiation resistance**

With ascending vacuum class motors are equally designed for higher radiation dose to be used in the vicinity of radiation sources (e.g. in medicine and research). While a fine vacuum motor can be safely used only up to a dose of 10 J/kg , a UHV motor may be safely operated up to a dose of 10^6 J/kg. A motor not designed for radiation will not only suffer degradation of the insulation and the adhesives - especially the grease of the ball bearing degrades, reduces the efficiency and ultimately blocks the motor.



Structure design

As is commonly done in high vacuum class all structural elements such as housing, flanges and shafts are made of stainless steel. Outgassing holes in the rear flange also allow rapid evacuation and purging of the motors and make sure that no gas inclusions may occur. All structural elements of the magnetic circuit are basically protected against corrosion. This also allows temporarily handling in normal environment.



Handling

phytron VSS motors are primarily designed for use in vacuum. Although the components of the magnetic circuit are basically protected against corrosion, the motors should ideally be handled in clean rooms and clean boxes. A storage is permitted only in phytron's original packaging. The motors are to be handled with suitable gloves. Since the rotor is magnetic, it must necessarily be handled in a clean environment so that no metal particles may be drawn into the motor. That could lead to an impairment of operation, reduce the life time or even cause the failure of the motor by blocking.



Service, Consulting and Customising

Of course we are happy if you are satisfied by our standard! But even if our in-Vacuum motor series contains the application experience of several decades - sometimes the standard is just not enough. We like to fit our motor for your application, because sometimes even small changes make all the difference. Special applications require special support: Our service experts are available even after the purchase.

Vacuum Classes

	Winding temperature [°C]	Vacuum class [ha]	Temperature sensor	Radiation-resistant up to [J/kg]	Conditioning of the components	First outgassing at phytron	TML [%]	CVCM [%]
FV	-20...+150	10 ⁻³	option	10	-	-	-	-
HV	-20...+200	10 ⁻⁷	option	10 ²	-	option	-	-
UHVS solid lubrication	-20...+300 ¹⁾	10 ⁻¹¹	type K ²⁾	10 ⁶	yes	yes	<1	<0.1
UHVG grease lubrication	-20...+300 ¹⁾	10 ⁻¹¹	type K ²⁾	10 ⁶	yes	yes	<1	<0.1
UHVC1 Cryo 1 solid lubrication	-200...+40	10 ⁻¹¹	option	10 ⁶	yes	-	<1	<0.1
UHVC2 Cryo 2 solid lubrication	-270...+40	10 ⁻¹¹	option	10 ⁶	yes	-	<1	<0.1

¹⁾ short-term ²⁾ Pt100 as an option

Extreme

Configuration guide

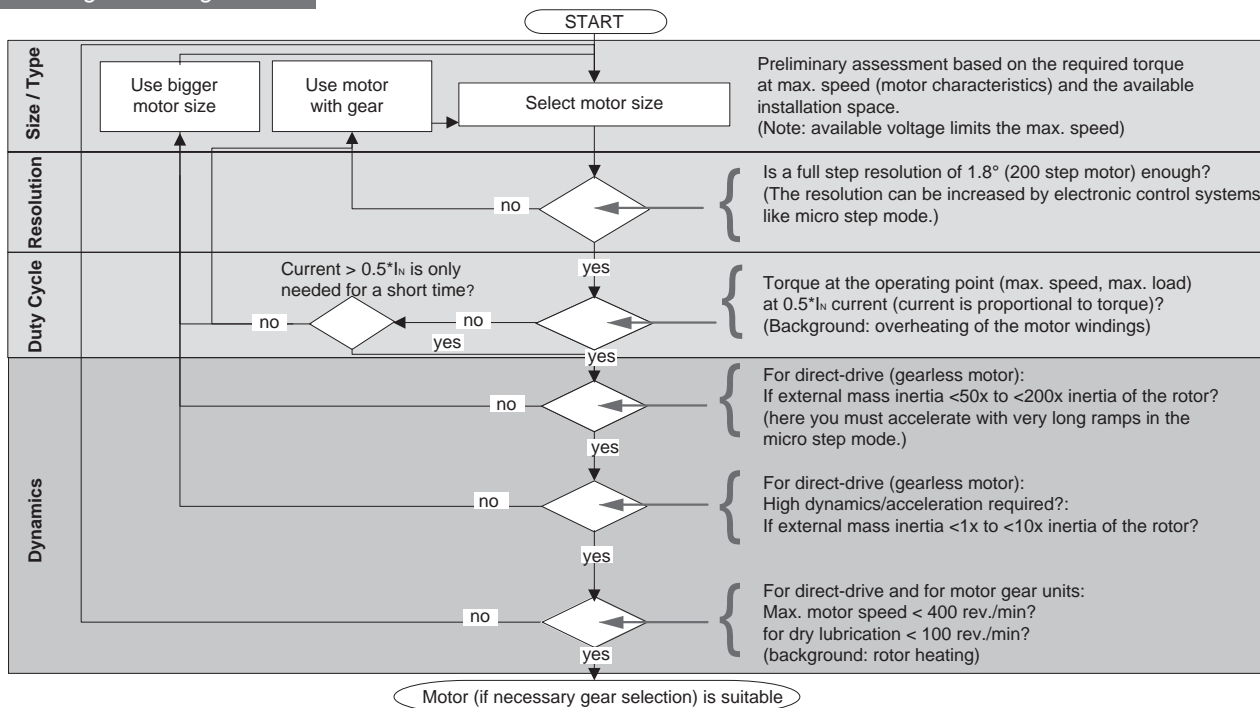

Derating - Duty-Cycle-Design for Applications in Vacuum

Motors driving in a vacuum heat up very quickly depending on their duty cycle. Driven with nominal current the maximum temperature will be reached within several minutes. Therefore it is necessary to monitor the motor's temperature (K-element) or to design a duty cycle with enough off-time to always keep the motor on a safe temperature level.

The shown curve is set at an environmental temperature of 20 °C. To give you an idea of how the chosen current influences the motor temperature we drew two curves of a VSS 57 motor. Driven with 400 rpm at 0.5 of the nominal current, the motor takes longer to heat up due to less ohmic losses then driven with the full nominal current.

The third curve (VSS 32) with 0.5 nominal current and 200 rpm only leads to a steady state temperature within the safe temperature limits. A higher rotational speed increases the magnetic losses. Therefore high speeds should be avoided as far as possible to reduce heat losses and to protect the bearings.

winding temperature (in vacuum), environment 20 °C

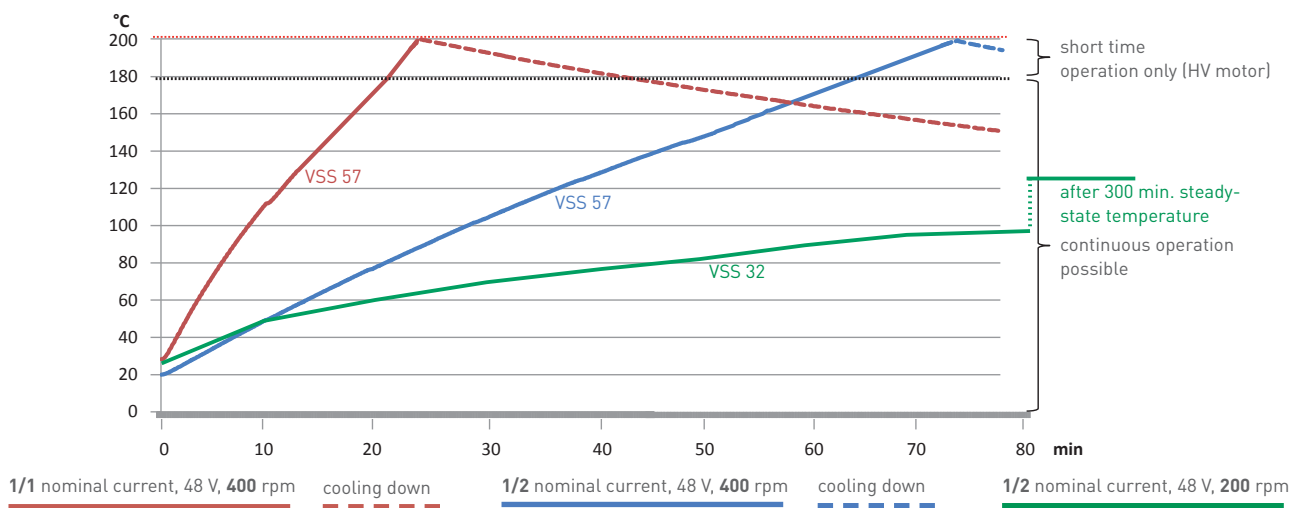

Stepper Motor VSS 19 to VSS 126

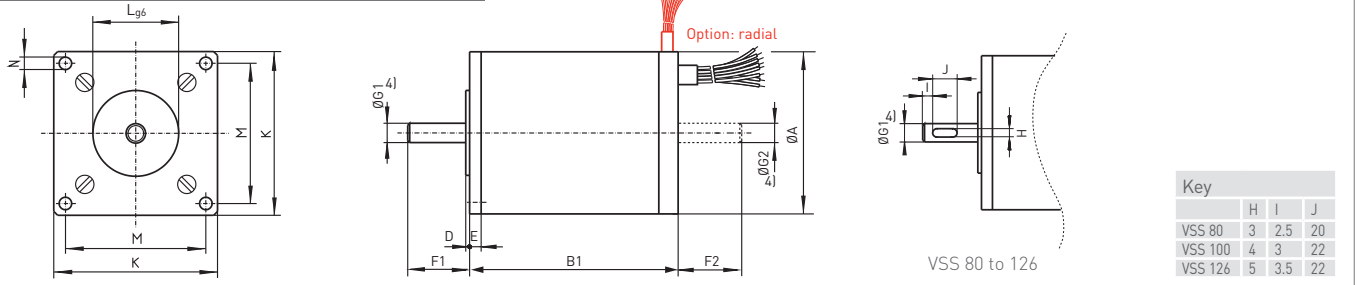

Dimensions / Electrical and Mechanical Characteristics

VSS Standard 200-steps 4 lead parallel ³⁾	Electrical Characteristics				Mechanical Characteristics							Dimensions in mm											
	Current/ Phase I _N	Resistance/ Phase	Inductivity/ Phase	max. operating voltage	AWG	Holding torque ²⁾	Detent torque	Rotor inertia	Loads		Mass	A	B1	D	E	F1	F2	G1 ⁴⁾	G2 ⁴⁾	K	L	M	N
									axial	radial													
A	Ω	mH	V _{DC}		mNm	mNm	kg cm ²	N	N	kg													
19.200.0.6¹⁾ 19.200.1.2¹⁾	0.6 1.2	2.1 0.63	0.85 0.23		28	3.4 3.5	0.9	0.0009	3	3	0.05	19	26.5	1	2	7.5	6.5	2.5	2.5	19	10	16	M2.5
20.200.0.6 20.200.1.2	0.6 1.2	3.45 0.95	1.1 0.4		28	8	1	0.002	3	3	0.075	19	43	1	2	7.5	6.5	2.5	2.5	19	10	16	M2.5
25.200.0.6 25.200.1.2¹⁾	0.6 1.2	3.25 0.95	1.5 0.4		28 26	12	2	0.0025	5	5	0.08	25	31	1	2.5	9.5	8.5	3	3	25	14	21.5	2.2
26.200.0.6 26.200.1.2	0.6 1.2	5.85 1.7	3.2 1.0		28 26	28	1.9	0.006	5	5	0.13	25	47	1	2.5	9.5	8.5	3	3	25	14	21.5	2.2
32.200.0.6 32.200.1.2¹⁾	0.6 1.2	4.6 1.25	5.3 1.2		26	40	3	0.01	5	15	0.17	32	38.5	1	3	11	10	4	4	32	18	27	2.8
33.200.0.6 33.200.1.2¹⁾	0.6 1.2	7.5 1.9	9.3 2.2		26	68	3.3	0.018	5	15	0.26	32	57.5	1	3	11	10	4	4	32	18	27	2.8
42.200.1.2¹⁾ 42.200.2.5¹⁾	1.2 2.5	1.7 0.34	3 0.7		24 22	120	5	0.045	20	40	0.35	42	54	1	3	16	15	5	4	42	22	36	3.2
43.200.1.2¹⁾ 43.200.2.5	1.2 2.5	2.6 0.5	5.2 1.2		24 22	235	7	0.077	20	40	0.52	42	69	1	3	16	15	5	4	42	22	36	3.2
52.200.1.2 52.200.2.5	1.2 2.5	2.65 0.6	7 1.6		24 22	350	13	0.15	25	70	0.72	52	65	1.5	3.5	17.5	16	6	4	52	28	44	4.3
56.200.1.2 56.200.2.5	1.2 2.5	3.9 0.8	9.5 2.4		24 22	420	30	0.17	40	80	0.78	56.4	58.1	1.5	4.5	22	20.5	6.35	6.35	60	38.1	47.1	5.2
57.200.1.2 57.200.2.5¹⁾	1.2 2.5	3.9 0.8	11.6 2.9		24 22	840	50	0.24	40	80	0.99	56.4	74.1	1.5	4.5	22	20.5	6.35	6.35	60	38.1	47.1	5.2
80.200.5	5	0.4	2.3		18	2300	120	1.24	50	180	2.8	80	100	2	7.5	27	25	10	9	80	50	68	6.4
100.200.10	10	0.15	2.1		16	4300	140	4.4	70	300	5	100	125.5	2	8	32	30	12	12	100	60	86	6.4
126.200.10	10	0.23	3.9		16	13000	290	18.2	150	700	13.9	125	210	3	9.5	34	31	14	14	125	60	108	8.4

¹⁾ Preferred options: HV and UHVG in small quantities are available from stock

²⁾ Holding torque in bipolar mode with parallel windings, two phases on at rated current

³⁾ other step resolutions on demand (with different mechanical characteristics!)

⁴⁾ Shaft diameter tolerances: VSS 19 to 26: -0.005 to -0.009; from VSS 32: g5

All values given above refer to room temperature and atmospheric pressure.

Extreme

Stepper Motor with VGPL Gear

Shaft		
VGPL	U1	Z1
16	2.8	8
22	3.5	8
26	4.5	12
32	6	0

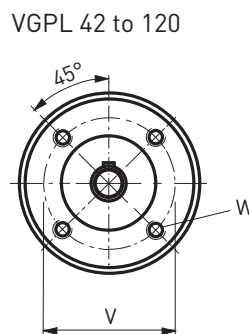
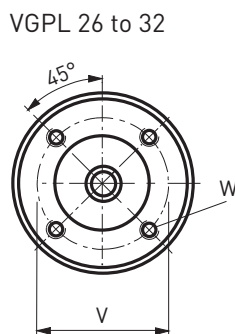
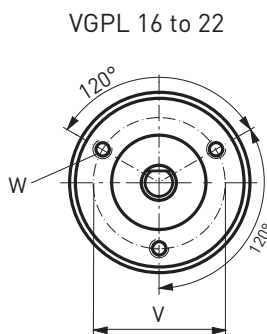
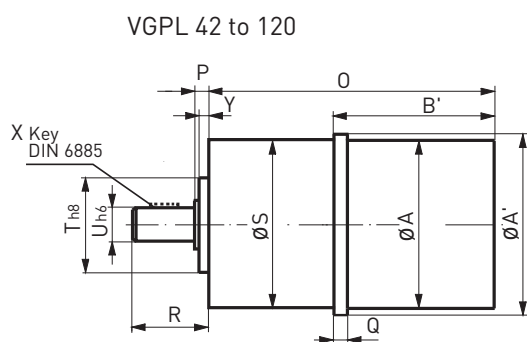
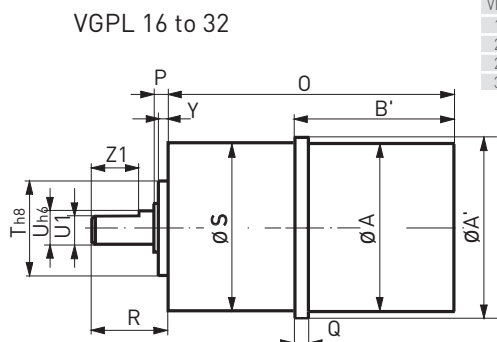

Dimensions

Gear	Stepper motor VSS	Dimensions in mm															Mass			
		Stages															Stages			
		A	A'	B'	O			P	Q	R	S	T	U	V	W	X	Y	1	2	3
VGPL 16	19 / 20	19	22	29	48 / 64.5	53 / 69.5	58 / 74.5	2	4.5	12.5	16	10	3	13	M 2x4	-	1.5	0.07 / 0.09	0.07 / 0.1	0.08 / 0.11
VGPL 22	19 / 20 / 25 / 26	19 / 25	22 / 25.5	29 / 33.5	50 / 66.5 / 54.5 / 70.5	57 / 73.5 / 61.5 / 77.5	64 / 80.5 / 68.5 / 84.5	2.5	5.5 / 5	15	22	12	4	16	M 2.5x4	-	2	0.5 / 0.12 / 0.13 / 0.18	0.13 / 0.15 / 0.15 / 0.2	0.15 / 0.17 / 0.18 / 0.23
VGPL 26	25 / 26	25	26	33.5	59 / 74.5	67 / 82.5	75 / 90.5	2.5	5	17	26	14	5	20	M 3x4	-	2	0.15 / 0.2	0.17 / 0.22	0.19 / 0.24
VGPL 32	32 / 33	32	33	40.5	69.5 / 88.5	78.5 / 97.5	87.5 / 106.5	4	5	20	32	20	6	26	M 3x5	-	3	0.31 / 0.4	0.35 / 0.44	0.42 / 0.51
VGPL 42	42 / 43	42	43	58	93 / 118	105.5 / 130.5	118 / 143	4	7	22.5	42	25	8	32	M 4x8	3x3x14	3	0.63 / 0.8	0.7 / 0.87	0.78 / 0.95
VGPL 52	52 / 56 / 57	52 / 56 / 57	53 / 57	68.5 / 62 / 78	109.5 / 103 / 119	124 / 117.5 / 133.5	138.5 / 132 / 148	4	6.7 / 7	24	52	32	12	40	M 5x8	4x4x16	3	1.2 / 1.48 / 1.69	1.3 / 1.6 / 1.81	1.45 / 1.7 / 1.91
VGPL 80	80	80	80	116	160	178	196	5	23.1	35	80	50	14	65	M 6x12	5x5x20	2.5	3.3	4.9	5.55
VGPL 105	80 / 100 / 126	80 / 100 / 125	105 / 105 / 125	116 / 146 / 210	183 / 208 / 277	205 / 235 / 299	232 / 262 / 326	6	23.1 / 8 / 9.5	46	105	70	20	85	M 8x20	6x6x28	2.5	6.05 / 8.25 / 17.15	7.55 / 9.75 / 18.65	9.05 / 11.25 / 20.25
VGPL 120	126	125	125	210	283.5	313.5	343.5	7.5	9.5	57.5	120	80	25	100	M 10x25	8x7x40	3	18.9	21.15	23.4

Mechanical Characteristics

Gear	Stepper motor	Gear back-lash ¹⁾⁵⁾⁶⁾⁷⁾			Rated torque ^{4) 6)8)}			Gear inertia			Radial load ²⁾	Axial load	Efficiency at full load ³⁾			reduction ratio i[:1]				
		arc-min			Nm			kg cm ²					%			i[:1]				
	VSS	Stage			Stage			Stage					Stage			Stage1	Stage 2	Stage 3		
		1	2	3	1	2	3	1	2	3			1	2	3					
VGPL 16	19 20	20	35	50	0.1	0.3	0.5	-	-	-	30	10				3 / 4	9 / 12 21 / 28 / 16	36 / 48 64 / 84 112 / 147 196		
VGPL 22	19 / 20 25 / 26	10 20	20 35	30 50	0.1	0.5	1.5	0.008	0.006	0.004	30	24				4 / 5	16 / 20 28 / 35	64 / 80 112 / 140 196 / 245		
VGPL 26	25 26				0.3	1	3	0.012	0.010	0.095	50	40						3.5 / 4.33	12.25 / 18.78 26 / 33.22	81.37 / 112.67 143.96 / 199.33
VGPL 32	32 33	8 20	12 35	15 50	0.4 0.8	2 4	6 6	0.015	0.012	0.011	80	65				4 / 4.5 5.2	12.08 / 16 18 / 20.8 25 / 29 32 / 36 41.6	64 / 72 / 81 100 / 130 144 / 200 225 / 256 288		
VGPL 42	42 43				0.7 1.4	4 8	12 12	0.03	0.024	0.024	150	120						3.5 / 4 5	12.25 / 14 16 / 20 24 / 25 30 / 30.67 38.33	49 / 56 64 / 70 / 80 100 / 120 144 / 184 235.11 / 293.89
VGPL 52	52 56 57	6 20	12 35	15 50	1.5 3	10 15	30 30	0.06	0.055	0.05	250	200				4 / 4.5 5.2 / 6.25	12.08 / 16 18 / 20.8 25 / 29 32 / 36 41.6 / 50	64 / 72 / 81 100 / 130 144 / 200 225 / 256 288 / 400		
VGPL 80	80				3 6	15 30	38 38	0.12	0.08	0.075	400	320						3.5 / 4 5	12.25 / 14 16 / 20 / 24 25 / 30 30.67 / 38.33 46	49 / 56 / 64 70 / 80 / 100 120 / 144 / 184 235.11 / 293.89
VGPL 105	80 100				12 25	60 120	150 150	1	0.85	0.8	800	640						3.5 / 4 5	12.25 / 14 16 / 20 24 / 25 30 / 30.67 38.33	49 / 56 64 / 70 / 80 100 / 120 144 / 184 235.11 / 293.89
VGPL 105	126							800	640						3.5 / 4	12.25 / 14 16 / 20 24 / 30.67	49 / 56 64 / 70 / 80 100 / 120 144 / 184 235.11			
VGPL 120	126				25 50	130 250	350 350	1.75	1.4	1.35	1500	1200				3.5 / 4 5	12.25 / 14 16 / 20 24 / 25 30	49 / 56 64 / 70 80 / 100 120 / 144 180		

¹⁾ no load ²⁾ center of the shaft ³⁾ in grease-lubricated operation ⁴⁾ continuous operation
⁵⁾ applies to FV, HV, UHVG for type reduced backlash ⁶⁾ applies to FV, HV, UHVG for type low backlash ⁷⁾ applies to UHVS, UHVC type standard backlash ⁸⁾ type standard backlash

Extreme

Stepper Motor with Resolver

In comparison to other resolvers with variable differential rotary transformer, the resolvers R02010 and R03620 use a constant air gap. They are less sensitive to eccentricity and magnetic stray fields and can directly be connected to standard resolver-to-digital-(R/ D)-converters.

The resolver is suitable for the use in fine, high and ultra high vacuum.

Kapton leads, 500 mm long

Accuracy: ± 60 arcmin (1 °)

Sense of Rotation

Positive when CCW seen from leads outlet

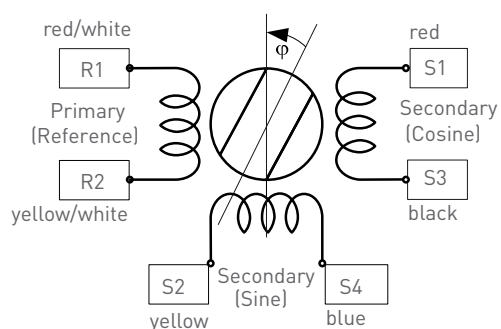

		No
R1	Ref+	1
R2	Ref-	2
S1	Cos+	3
S3	Cos-	4
S2	Sin+	5
S4	Sin-	6

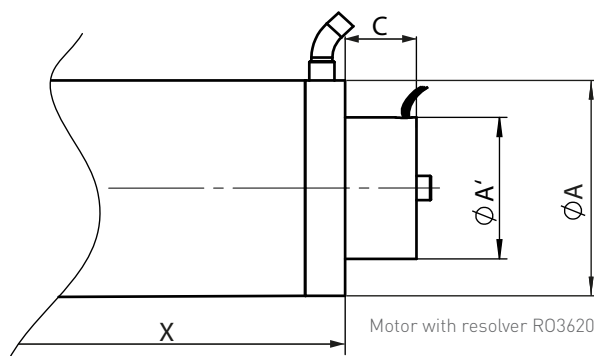

Resolver Specification

Resolver	Stepper motor	A	A'	C	X	Electrical Characteristics			Rotor inertia [gcm ²]	Mass [g] (Resolver)
						Excitation amplitude [V _{r.m.s.}]	Excitation frequency [kHz]	Transformation ratio		
R02010	VSS 25 VSS 26	25	20	17.5	33.5	2 to 12	5 to 50	0.5 ± 10 %	1	30
R02010	VSS 32 VSS 33	32			41.5 60.5					
R03620	VSS 42 VSS 43	42	56.5 71.5							
R03620	VSS 52 VSS 56 VSS 57	52	65 75		10.9				85	
		56								
R03620	VSS 80	80	100							
R03620	VSS 100	100	125.5							
R03620	VSS 126	125	156							

Resolver - Encoder Converter



The position data converter controls autonomously the resolver sensor and converts the output signals of the resolver to incremental output signals (square wave signal).

Resolution: 1024 increments

Output reference signal: 8 V_{PP} (diff.)
100 mA max.
10 kHz

Input SIN/COS: 4 V_{PP} (max.)

Resolver transformation factor: K= 0,5

Supply voltage: 24 V (14...36 V_{DC})

Phytron ID: # 10011284

Resolver connection to the Converter:

Pin	Ref-
Pin 1	-
Pin 2	-
Pin 3	-
Pin 4	-
Pin 5	SIN+
Pin 6	SIN
Pin 7	Ref+
Pin 8	COS+
Pin 9	COS
Screen	PE

phytron's modular *phyMOTION*[™] controller evaluates the resolver signals directly with the newly developed resolver evaluation module ECMS01.

Thermocouple Type K and Resistance Temperature Detektor Pt100

The insulated temperature sensor in phytron motors is integrated in the motor windings. The response time to temperature changes of the winding is very short, compared to temperature sensors mounted outside the motor housing. The temperature is measured all the time (even only one motor phase is powered at any time), because the sensors are always mounted between the phases.

Thermocouple element type K

phytron uses with the Type K (NiCr-Ni) in-vacuum and cryo stepper motors, thermal elements in the temperature range from -270 to +1370 °C, accuracy class 1. The Type K is a metal thermal element with nickel-based alloy conductors. Temperature ranges, accuracy and characteristics of thermal elements for industrial use are defined in the IEC 584 standard (temperature measuring with thermal elements)

The accuracy of the temperature measuring depends on the temperature of the reference point.

Resistance temperature detector (RTD) Pt100

phytron uses Pt100 resistor sensors in in-vacuum and cryo stepper motors in the temperature range -200 to +300 °C. These precise sensors are used in extreme industrial and laboratory conditions. They consist of a wound resistance wire that is mounted and unsupported inside a cylindrical ceramic case

The evaluation of the temperature measuring is possible with the corresponding module in the *phyMOTION*[™] controller. For the K type variations to some degree are possible.

Phytron devices and controllers for the evaluation of Pt100 resistor sensors and thermal element type K

1-axis controller MCC-1
2-axes controller MCC-2
Multi-axes controller *phyMOTION*[™]

Extreme

Option: Shaft design with flat surface

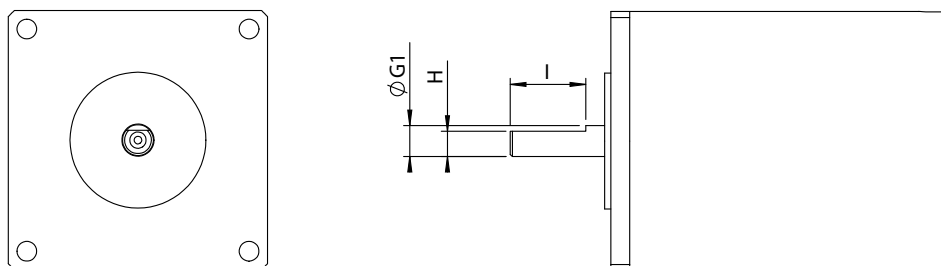

Dimensions

Stepper motor	Dimensions in mm		
Typ	G1	H	l
VSS19	2,5	2	4,5
VSS25 VSS26	3	2,5	6,5
VSS32 VSS33	4	3,5	8
VSS 42 VSS 43	5	4	13
VSS 52	6	5	14
VSS 56 VSS 57	6,35	5,5	18,5

More shaft options on demand.

Torque Characteristics

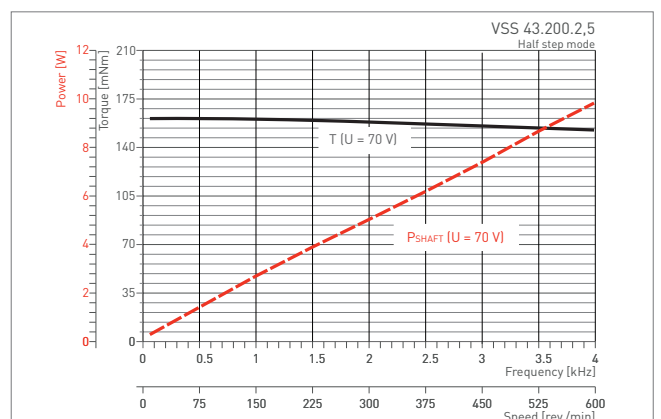
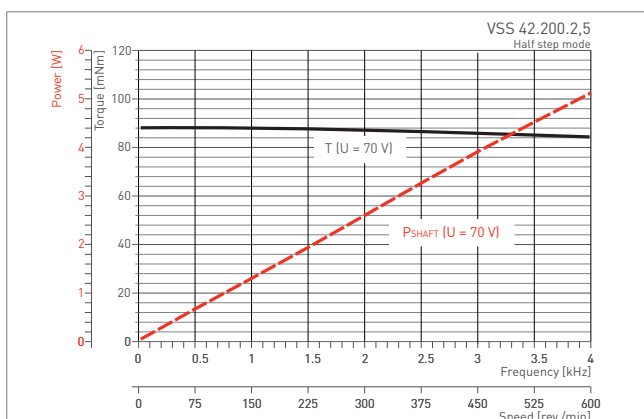
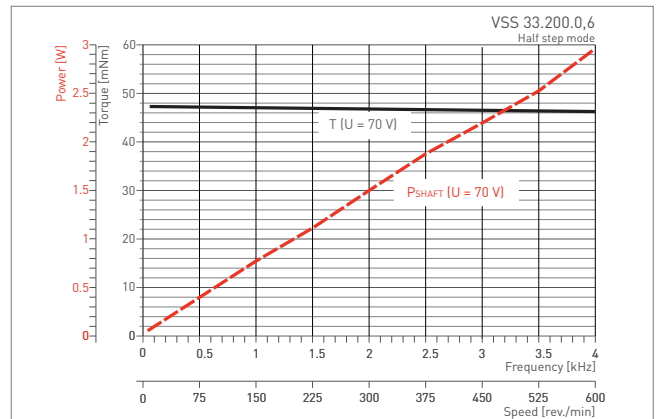
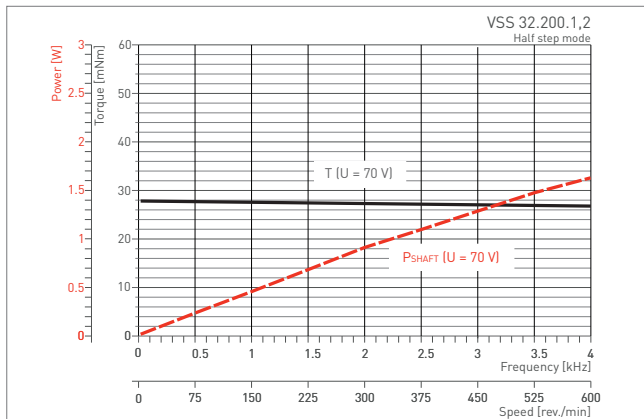
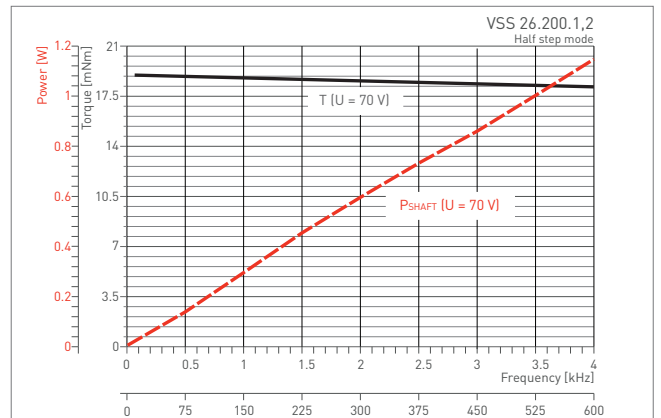
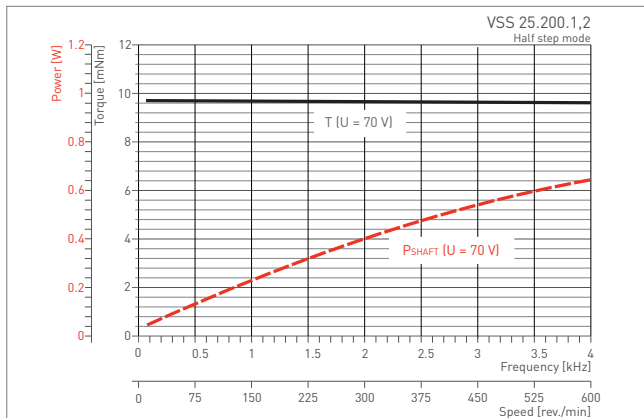
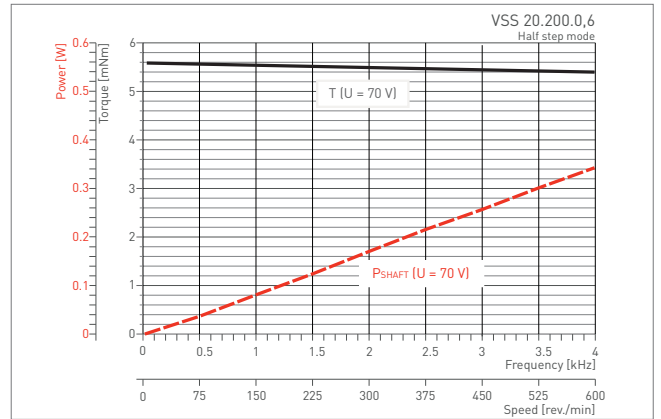
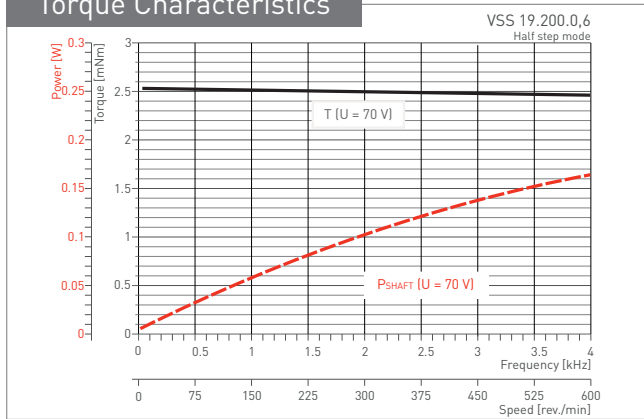

Extreme

Torque Characteristics

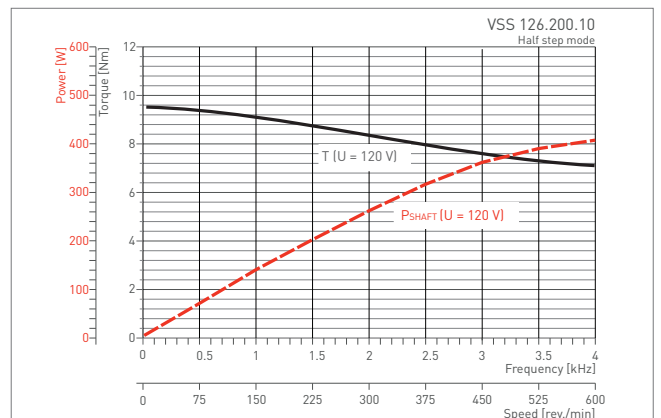
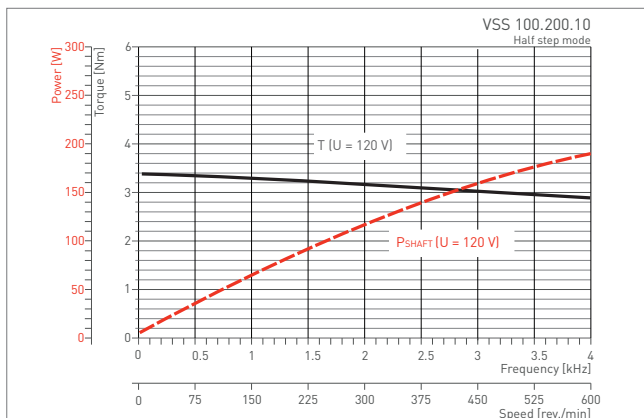
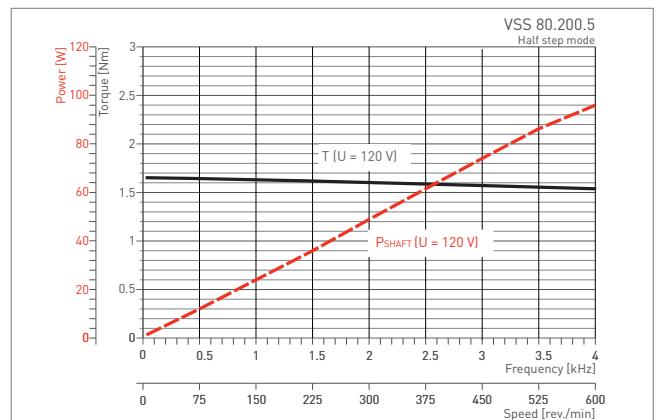
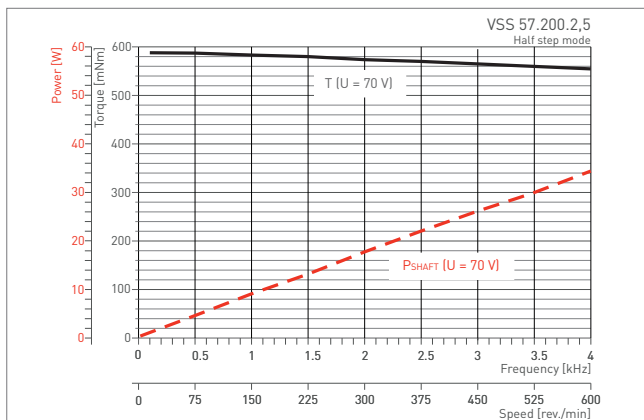
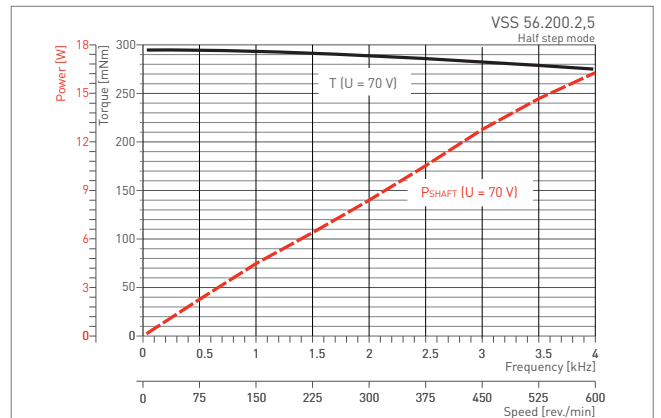
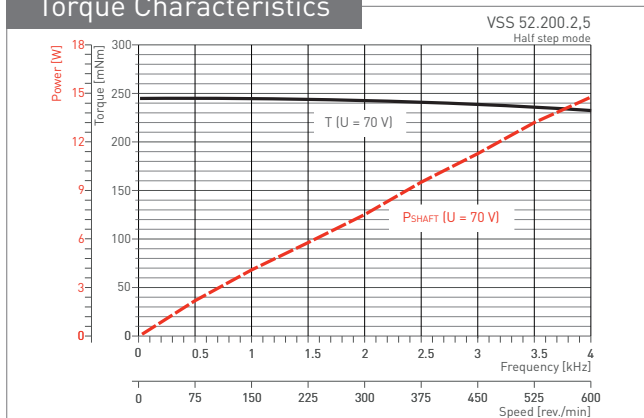

U = 70 V_{DC} / 120 V_{DC}: Operating voltage of the power stage (intermediate circuit voltage)

Efficient Customising - the perfect fit

Combine efficiently standard components, modifications & specials

For 30 years we have used our know-how in a lot of successful space projects to optimise our vacuum series for industrial and scientific applications in the matter of performance and cost efficiency. The specific designs of the two-phase hybrid stepper motors have been designed for use in vacuum up to 10^{-11} hPa. Phytron vacuum stepper motors are conditioned at up to 250 °C for use in the **high-(HV) or ultra-high vacuum (UHV)** and are designed dependent on the applications for the **low-temperature range up to -196 °C (N₂), -269 °C (He), or high-temperature range (winding temperature up to +300 °C)** and, if necessary, also for **radiation up to 10^6 J/kg**.

Starting from the VSS series we have already implemented a number of customer specific projects. Performance, housings, flanges, materials, shaft machining – in the common specification process, the VSS platform can be optimised for your project. With our high in-house production depth we are not only technologically very flexible, we can also produce small quantities.

Applications

Our vacuum motors, power stages or controllers are driving in a lot of different applications:

- Particle accelerators and X-ray measuring systems (PETRA III, PANTER, FERMI, PAL, SOLEIL,...)
- Devices for molecular analysis
- Electron microscope
- Sputtering systems
- Cryostats

Stepper motor spindle version for a particle accelerator

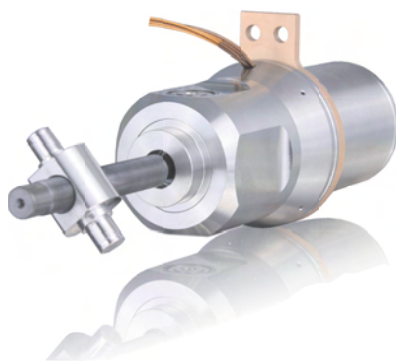

Adjustment of particle accelerator cavities

- stepper motor with 200 steps/revolution (1.8°), with integrated gear 50:1 (10:000 steps/revolution)
- designed for 1300 N axial force
- spindle and nut system, non-magnetic
- material for housing, flanges and internal parts stainless steel or titanium
- dry lubricated for usage under vacuum at -270 °C up to +40 °C (also as grease lubricated version for environments > 35 °C)
- optional EMC cable shielding
- thermocouple K-type in winding

Extreme

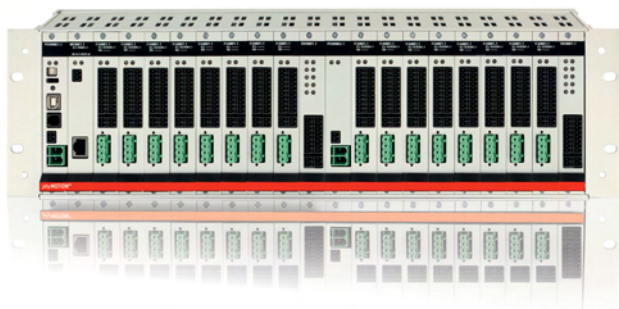
Motion controller for vacuum application: *phyMOTION™*

Modular stepper motor controller for in-vacuum applications

The *phyMOTION™* controller is ideally equipped for the demands of in-vacuum projects. Beside the encoder evaluation (differential incremental encoder with quadrature signals, absolute encoder acc. to SSI standard, EnDat-encoder) a resolver and temperature sensor evaluation of each axis is possible for monitoring of the driven motors. This functions can be integrated as optional sub-modules of each axis – in addition to the default limit switch evaluations of each axis. So, you pay only what you really need. The better part of cabling effort is eliminated because the power stages are already integrated.

You can combine with 6 to 21 modules of each housing up to 18 power stages with different functions (axis modules, digital I/O, analogue I/O, 4-axis indexer for interpolation, integrated display)

Via freely selectable HOST interface (Profibus, Profinet, Ethernet, RS232, RS484, USB, Bluetooth) and provided drivers and protocols (LabVIEW VI, EPICS) you can seamlessly integrate the *phyMOTION™* also below existing systems.

Operate the *phyMOTION™* as free programmable stand-alone controller, as distributed intelligence, or also as a slave system i.e. below existing PLC systems.



Encoder types suitable for the **encoder evaluation**:

- Differential incremental encoder with Quadratic signals
- Absolute encoder acc. to SSI standard
- EnDat encoder
- Resolver

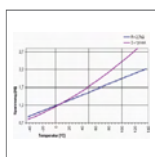

Temperature evaluation module for **stepper motor temperature monitoring**

Thermal elements type K or Pt100 resistor sensors can be used. The insulated temperature sensor in phytron motors is integrated in the motor windings. The response time is very short. The temperature is measured all the time, even if only one motor phase is powered at any one time.



Control via Android-based integrated touch panel (TPM01) or via Android-based tablets (from version V4.0)

- As user interface i.e. for parameter selection
- For support, parameterisation and diagnostics



LabVIEW®-VI

VIs for *phyMOTION®* – simulation software with graphical style

Use the VIs (Virtual instruments) generated by Phytron and integrate them in your LabVIEW® project. So you can easily control the phytron controller *phyMOTION™* from your usual programming environment.

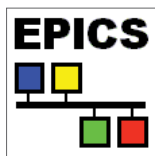

Software environment to develop and realise distributed control systems for large-scale experiments such as telescopes and accelerators. EPICS provides the SCADA support.

Phytron delivers the source code to integrate the phytron controller *phyMOTION™* into EPICS environment. Also in multi-axis operation: positioning, limit-switches, encoder evaluation



Extreme

Electrical Connection

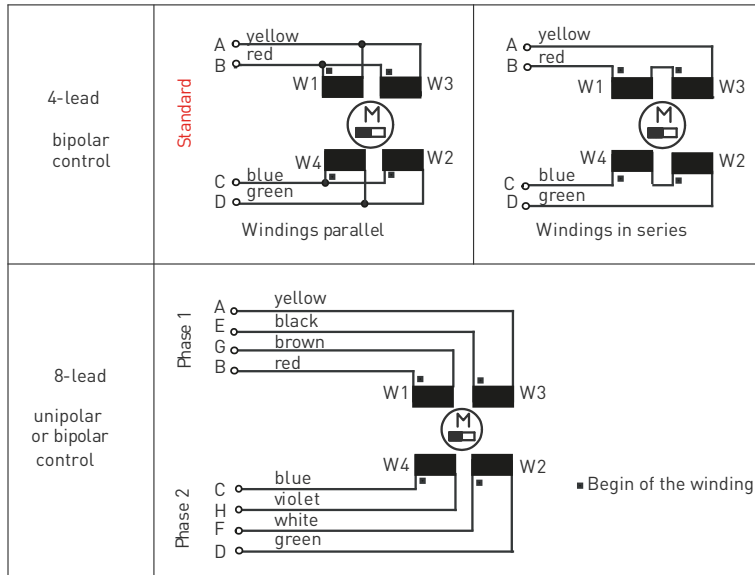

All illustrations, descriptions and technical specifications are subject to modifications; no responsibility is accepted for the accuracy of this information.

Ordering Code

The variable elements of the product are displayed in colour.

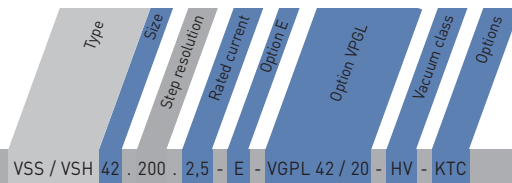

Options		
Size	19 - 125	
Rated current [A/Phase]	0,6 1,2 2,5 5 10	for VSS 19 to 33 for VSS 19 to 57 for VSS 42 bis 57 for VSS 80 for VSS 100 bis 126
Option E	E	Double shaft no double shaft
Option VGPL	VGPL xx/xx	Low backlash gear: size / reduction ratio no gear
Vacuum class	FV HV UHVS UHVG UHVC1 UHVC2	Fine vacuum High vacuum Ultra high vacuum dry coated bearing Ultra high vacuum greased bearing Ultra high vacuum Cryo temperature down to liquid Nitrogen Ultra high vacuum Cryo temperature down to liquid Helium
Options	R KTC Pt RS X	Radial wire outlet Thermocouple type K*) Resistance temperature detector Resolver customised no

*) Standard for vacuum class UHVS and UHVG.

Phase currents

Admissible phase currents for identical power dissipation	
Bipolar control mode Full step operation	
4-lead motor	4-lead motor
parallel windings	series windings
rated current	50% of the rated current

Phytron GmbH

Industriestraße 12 – 82194 Gröbenzell
T +49-8142-503-0 F +49-8142-503-190